

General

- Chip size from 0805 to 2512
- Resistance value from 1mΩ to 50mΩ
- Low thermal EMF
- Low TCR
- Lead free, RoHS compliant for global
- Applications and halogen free

Application

- Switching model power supply.
- Battery pack.
- Notebook, personal computer.
- Test Instrument.
- Power Amplifier.

Electrical Specifications

Type	Power Rating at 70°C(W)	Resistance Range (mΩ)	TCR (ppm/°C)	Resistance tolerance	Operation Temp. Range
0805	1	1	±100	±1%(F),±2%(G)	-55°C~+170°C
		2≤R≤9		±1%(F)	
		10≤R≤50	±50	±0.5%(D) ±1%(F)	
1206	1.5	1≤R≤9	±100	±1%(F)	
		10≤R≤50	±50	±0.5%(D) ±1%(F)	
2512	3	1≤R≤9	±100	±1%(F)	
		10≤R≤50	±50	±0.5%(D) ±1%(F)	

Part Number information

SME 25 A 3 F R002 T

【1】 【2】 【3】 【4】 【5】 【6】 【7】

【1】 Series Name: SART Metal Foil Long Electrode Type

【2】 Chip size: 08:0805 12:1206 25:2512

【3】 Material Code:A:Alloy

【4】 Power Code:3:3W 1:1W B:1.5W

【5】 Resistance Tolerance: D:±0.5% F:±1% G:±2%

【6】 Resistance Code: R002=2mΩ

【7】 Packaging Code: T:Tape& Reel B:Bulk Pack

Dimensions

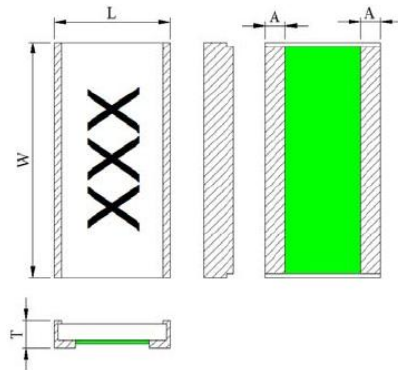

Type	Resistance (mΩ)	W (mm)	L (mm)	T (mm)	A (mm)
0805	1~50	2.10±0.20	1.35±0.20	0.65±0.20	0.45±0.20
1206	1	3.30±0.20	1.70±0.20	0.65±0.20	0.55±0.30
	2~50	3.30±0.20	1.70±0.20	0.65±0.20	0.40±0.20
2512	1~50	6.40±0.30	3.20±0.30	0.65±0.20	0.60±0.20

Recommended Land Patterns

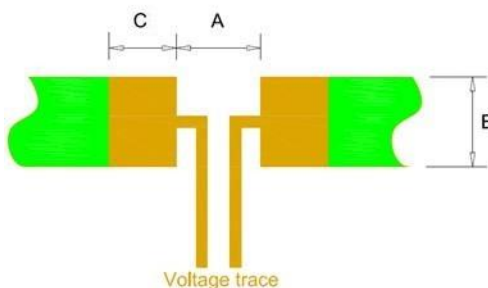

Type	Resistance (mΩ)	A (mm)	B (mm)	C (mm)
0805	1~50	0.60	2.30	1.10
1206	1	0.50	3.68	1.35
	2~50	0.60	3.68	1.30
2512	1~50	1.40	7.25	2.35

Materials

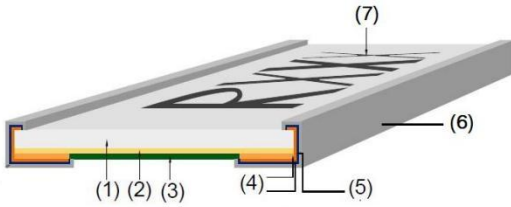

No.	Material	No.	Material
1	Ceramic substrate	5	Nickel
2	Alloy	6	Tin
3	Protective coating	7	Marking
4	Copper	/	/

Power Derating Curve

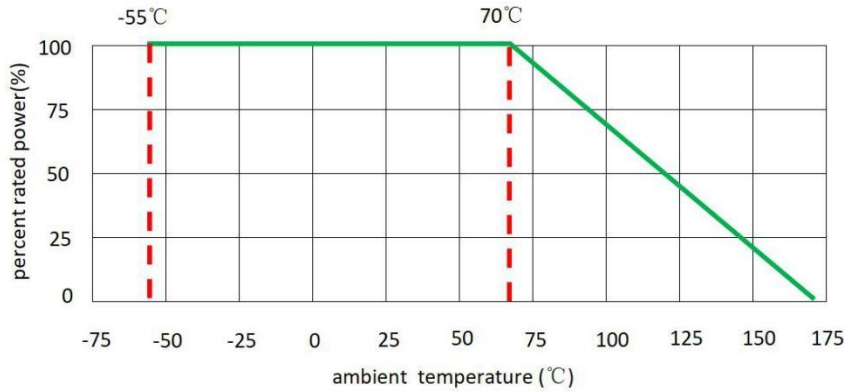

Recommended Solder Curve

1. Infrared Reflow

- Temperature: 260°C
- Time: 5sec Max.
- Recommend Reflow profile:

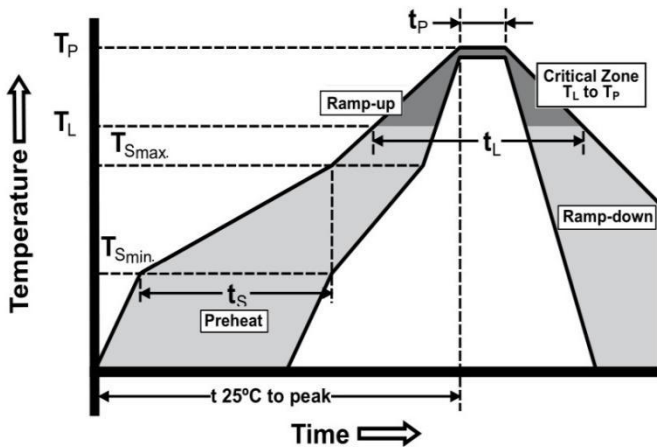

Profile Feature	Pb-Free Assembly
Average Ramp-up Rate (T _{Smax} to T _p)	3°C/sec Max.
Preheat Temperature Min.(T _{Smin}) Temperature Max.(T _{Smax}) Time(T _{Smin} to T _{Smax})	150°C 200°C 60sec~120sec
Peak Temperature(T _p)	260°C
Time within 5°C of actual Peak Temperature(T _p)	5sec
Melting tin time(T _L)	20sec~30sec
Ramp-down Rate	6°C/sec Max.
Time 25°C to peak Temperature	8 min Max.

2. Wave soldering

- Reservoir Temperature: 260°C
- Time in Reservoir: 10sec Max.

3. Hand Soldering

- Temperature: 350°C
- Time: 5sec Max.

Product Characteristics

Item	Test condition / Methods	Performance	Standard
Short Time Overload	P= 2.5Pr; T=25°C±2°C , t = 5sec	\ΔR ≤±(1%+0.5 mΩ)	IEC 60115-1 4.13
Temperature Coefficient of Resistance (TCR)	TCR =(R-R ₀)/R ₀ (T ₂ -T ₁)X 10 ⁶ Test temperature: +25°C~+125°C	Refer to SART Spec	IEC 60115-1 4.8
Thermal Shock	-55°C(30min)/+150°C(30min), 100 cycles	\ΔR ≤±(1%+0.5 mΩ)	IEC 60115-1 4.19
Resistance to Solder Heat	265°C±5°C, 20sec±1sec	\ΔR ≤±(1%+0.5mΩ)	IEC 60115-1 4.18
Solderability	245°C±5°C, 3sec±0.5sec	95% coverage Min.	IEC 60115-1 4.17
Load Life	1000 hours at rated power, 70°C±2°C, 1.5hours "ON", 0.5hours "OFF"	\ΔR ≤±(2% +0.5 mΩ)	IEC 60115-1 4.25
Moisture Load Life (60°C、95%RH)	T=60±2°C ; RH=95% ;V _{test} = V _{max} ; t=1.5hours "ON",0.5hours "OFF" , 1000hours	\ΔR ≤±(2%+0.5 mΩ)	IEC 60115-1 4.24
Bending test	Bending width 2mm, Epoxy thickness 1.6mm, Fulcrums distance 90mm	\ΔR ≤±(1%+0.5 mΩ)	IEC 60115-1 4.33
High Temp. Exposure	T = +170°C±2°C ; t = 1000hours	\ΔR ≤±(1%+0.5 mΩ)	IEC60115-1 4.23
Low Temp. Storage	T = -55°C±2°C ; t = 1000hours	\ΔR ≤±(1%+0.5 mΩ)	IEC60115-1 4.23
Mechanical Shock	a =100g`s , t =11ms, 5 times shock	\ΔR ≤±(1%+0.5 mΩ)	IEC60115-1 4.21

Packaging

1. Embossed Tape Dimensions

For 0805

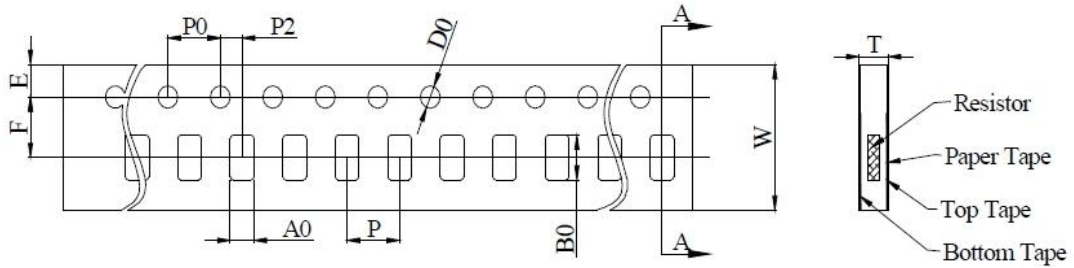

Type	A0 (mm)	B0 (mm)	W (mm)	F (mm)	E (mm)
0805	1.68±0.20	2.38±0.20	8.00±0.30	3.50±0.10	1.75±0.10
Type	P (mm)	P2 (mm)	P0 (mm)	D0 (mm)	T (mm)
0805	4.00±0.10	2.00±0.10	4.00±0.10	1.50±0.10	0.87±0.20

For 1206&2512

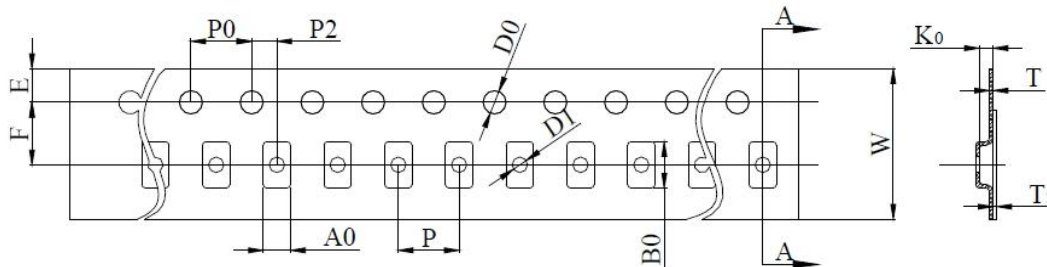

Type	A0 (mm)	B0 (mm)	W (mm)	F (mm)	E (mm)	P (mm)
1206	2.05±0.20	3.65±0.20	8.00±0.30	3.50±0.10	1.75±0.10	4.00±0.10
2512	3.40±0.20	6.75±0.20	12.00±0.30	5.50±0.10	1.75±0.10	4.00±0.10
Type	P2 (mm)	P0 (mm)	D0 (mm)	T (mm)	T1 (mm)	K0 (mm)
1206	2.00±0.10	4.00±0.10	1.50±0.10	0.20±0.10	0.1 Max.	0.85±0.20
2512	2.00±0.10	4.00±0.10	1.50±0.10	0.25±0.10	0.1 Max.	1.00±0.20

2. Reel Dimensions

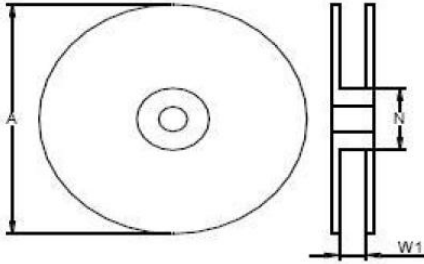

Type	A (mm)	N (mm)	W1 (mm)
0805	178.00±5.00	60.00±2.00	9.00±1.00
1206	178.00±5.00	60.00±2.00	9.00±1.00
2512	178.00±5.00	60.00±2.00	13.00±1.00

3. Quantity of Package

Type	Quantity(pcs)
0805	5000
1206	5000
2512	4000

4. Peeling Test

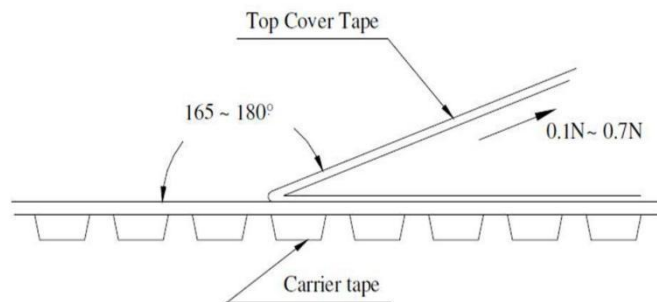

Storage

- The ambient temperature shall between 5°C~30°C.
- The relative humidity recommended for storage is between 25%RH~60%RH.
- Sealed plastic bags with desiccant shall be used to reduce the oxidation of the termination and shall only be opened prior to use.
- The products shall not be stored in areas where harmful gases containing sulfur or chlorine are present.